

FEATURES

- Two inputs, one output HDMI/DVI links
- Enables HDMI 1.2a-compliant receiver
- Four TMDS channels per link
 - Supports 250 Mbps to 1.65 Gbps data rates
 - Supports 25 MHz to 165 MHz pixel clocks
 - Equalized inputs for operation with long HDMI cables (20 meters at 1080p)
 - Fully buffered unidirectional inputs/outputs
 - Globally switchable 50 Ω on-chip terminations
 - Pre-emphasized outputs
 - Low added jitter
- Single-supply operation (3.3 V)
- Four auxiliary channels per link
 - Bidirectional unbuffered inputs/outputs
 - Flexible supply operation (3.3 V to 5 V)
 - HDCP standard compatible
 - Allows switching of DDC bus and two additional signals
- Output disable feature
 - Reduced power dissipation
 - Output termination removal
- Two AD8190s support HDMI/DVI dual-link
- Standards compliant: HDMI receiver, HDCP, DVI
- Serial (I²C slave) control interface
- 56-lead, 8 mm x 8 mm, LFCSP, Pb-free package

APPLICATIONS

- Multiple input displays
- Projectors
- A/V receivers
- Set-top boxes
- Advanced television (HDTV) sets

GENERAL DESCRIPTION

The AD8190 is an HDMI/DVI switch featuring equalized TMDS inputs and pre-emphasized TMDS outputs, ideal for systems with long cable runs. Outputs can be set to a high impedance state to reduce the power dissipation and/or allow the construction of larger arrays using the wire-OR technique.

The AD8190 is provided in a space saving, 56-lead, LFCSP, surface-mount, Pb-free, plastic package and is specified to operate over the -40°C to +85°C temperature range.

Rev. 0

Information furnished by Analog Devices is believed to be accurate and reliable. However, no responsibility is assumed by Analog Devices for its use, nor for any infringements of patents or other rights of third parties that may result from its use. Specifications subject to change without notice. No license is granted by implication or otherwise under any patent or patent rights of Analog Devices. Trademarks and registered trademarks are the property of their respective owners.

FUNCTIONAL BLOCK DIAGRAM

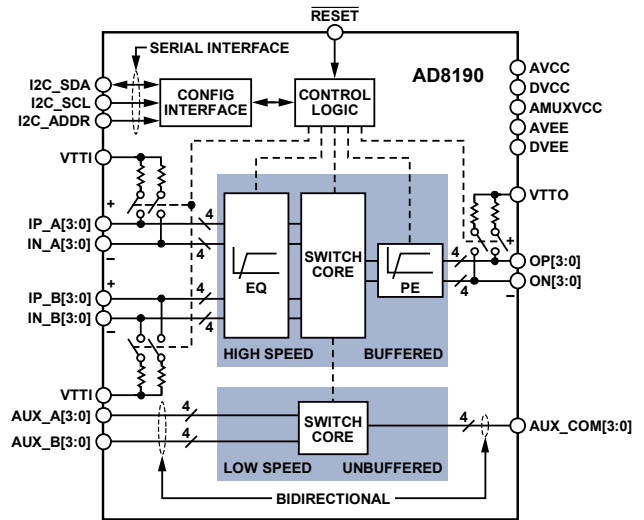

Figure 1.

TYPICAL APPLICATION

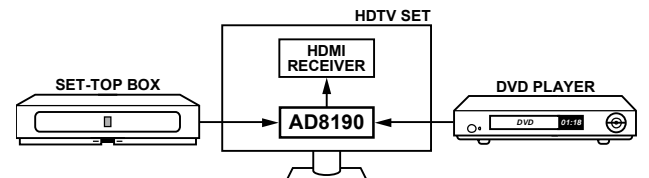

Figure 2. Typical AD8190 Application for HDTV Sets

PRODUCT HIGHLIGHTS

1. Supports data rates up to 1.65 Gbps, enabling UXGA (1600 × 1200) DVI resolutions and 1080p HDMI formats.
2. Input cable equalizer enables use of long cables at the input (more than 20 meters of 24 AWG cable at 1080p).
3. Auxiliary switch allows routing of the DDC bus and two additional single-ended signals for a single chip, fully HDMI 1.2a receive-compliant solution.

TABLE OF CONTENTS

| | | | |
|--|----|---|----|
| Features | 1 | Serial Control Interface | 14 |
| Applications..... | 1 | Reset | 14 |
| Functional Block Diagram | 1 | Write Procedure..... | 14 |
| Typical Application..... | 1 | Read Procedure..... | 15 |
| General Description | 1 | Switching/Update Delay | 15 |
| Product Highlights | 1 | Configuration Registers..... | 16 |
| Revision History | 2 | High Speed Device Modes Register | 16 |
| Specifications..... | 3 | Auxiliary Device Modes Register..... | 16 |
| Absolute Maximum Ratings..... | 5 | Receiver Settings Register | 17 |
| Thermal Resistance | 5 | Input Termination Pulse Register | 17 |
| Maximum Power Dissipation | 5 | Receive Equalizer Register | 17 |
| ESD Caution..... | 5 | Transmitter Settings Register..... | 17 |
| Pin Configuration and Function Descriptions..... | 6 | Application Notes | 18 |
| Typical Performance Characteristics | 8 | Pinout..... | 18 |
| Theory of Operation | 12 | Cable Lengths and Equalization..... | 19 |
| Introduction | 12 | The AD8190 as a Single-Channel Buffer | 19 |
| Input Channels..... | 12 | PCB Layout Guidelines..... | 19 |
| Output Channels | 12 | Outline Dimensions | 23 |
| Switching Mode | 13 | Ordering Guide | 23 |
| Auxiliary Lines Switching..... | 13 | | |

REVISION HISTORY

7/06—Revision 0: Initial Version

SPECIFICATIONS

$T_A = 27^\circ\text{C}$, $AVCC = 3.3\text{ V}$, $V_{TTI} = 3.3\text{ V}$, $V_{TTO} = 3.3\text{ V}$, $DVCC = 3.3\text{ V}$, $AMUXVCC = 5\text{ V}$, $AVEE = 0\text{ V}$, $DVEE = 0\text{ V}$, differential input swing = 1000 mV, TMDS outputs terminated with external 50 Ω resistors to 3.3 V, unless otherwise noted.

Table 1.

| Parameter | Conditions/Comments | Min | Typ | Max | Unit |
|--|--|--------------|------|------------------|----------|
| DYNAMIC PERFORMANCE | | | | | |
| Maximum Data Rate (DR) per Channel | NRZ | 1.65 | | | Gbps |
| Bit Error Rate (BER) | PRBS 2 ²³ – 1 | | | 10 ⁻⁹ | |
| Added Deterministic Jitter | DR \leq 1.65 Gbps, PRBS 2 ²³ – 1 | | 40 | | ps (p-p) |
| Added Random Jitter | | | 1 | | ps (rms) |
| Differential Intrapair Skew | At output | | 1 | | ps |
| Differential Interpair Skew ¹ | At output | | 40 | | ps |
| EQUALIZATION PERFORMANCE | | | | | |
| Receiver (Highest Setting) ² | Boost frequency = 825 MHz | | 12 | | dB |
| Transmitter (Highest Setting) ³ | Boost frequency = 825 MHz | | 6 | | dB |
| INPUT CHARACTERISTICS | | | | | |
| Input Voltage Swing | Differential | 150 | | 1200 | mV |
| Input Common-Mode Voltage (V_{ICM}) | | $AVCC - 800$ | | $AVCC$ | mV |
| OUTPUT CHARACTERISTICS | | | | | |
| High Voltage Level | Single-ended high speed channel | $AVCC - 10$ | | $AVCC + 10$ | mV |
| Low Voltage Level | Single-ended high speed channel | $AVCC - 600$ | | $AVCC - 400$ | mV |
| Rise/Fall Time (20% to 80%) | | 75 | 135 | 200 | ps |
| INPUT TERMINATION | | | | | |
| Resistance | Single-ended | | 50 | | Ω |
| AUXILIARY CHANNELS | | | | | |
| On Resistance, R_{AUX} | | | 100 | | Ω |
| On Capacitance, C_{AUX} | DC bias = 2.5 V, ac voltage = 3.5 V, f = 100 kHz | | 8 | | pF |
| Input/Output Voltage Range | | $DVEE$ | | $AMUXVCC$ | V |
| POWER SUPPLY | | | | | |
| $AVCC$ | Operating range | 3 | 3.3 | 3.6 | V |
| QUIESCENT CURRENT | | | | | |
| $AVCC$ | Outputs disabled | 30 | 40 | 45 | mA |
| | Outputs enabled, no pre-emphasis | 53 | 60 | 66 | mA |
| | Outputs enabled, maximum pre-emphasis | 98 | 108 | 120 | mA |
| V_{TTI} | Input termination on ⁴ | 5 | 40 | 54 | mA |
| V_{TTO} | Output termination on, no pre-emphasis | 36 | 40 | 44 | mA |
| | Output termination on, maximum pre-emphasis | 73 | 80 | 88 | mA |
| $DVCC$ | | 4 | 7 | 10 | mA |
| $AMUXVCC$ | | | 0.01 | 0.1 | mA |
| POWER DISSIPATION | | | | | |
| | Outputs disabled | 115 | 271 | 364 | mW |
| | Outputs enabled, no pre-emphasis | 411 | 574 | 664 | mW |
| | Outputs enabled, maximum pre-emphasis | 754 | 936 | 1057 | mW |
| TIMING CHARACTERISTICS | | | | | |
| Switching/Update Delay | High speed switching register: HS_CH | | | 200 | ms |
| | All other configuration registers | | | 1.5 | μ s |
| $\overline{\text{RESET}}$ Pulse Width | | 50 | | | ns |

AD8190

| Parameter | Conditions/Comments | Min | Typ | Max | Unit |
|---------------------------------------|---------------------|-----|-----|-----|------|
| SERIAL CONTROL INTERFACE ⁵ | | | | | |
| Input High Voltage, V_{IH} | | 2 | | | V |
| Input Low Voltage, V_{IL} | | | | 0.8 | V |
| Output High Voltage, V_{OH} | | 2.4 | | | V |
| Output Low Voltage, V_{OL} | | | | 0.4 | V |

¹ Differential interpair skew is measured between the TMDS pairs of a single link.

² AD8190 output meets the transmitter eye diagram as defined in the DVI Standard Revision 1.0 and the HDMI Standard Revision 1.2a.

³ Cable output meets the receiver eye diagram mask as defined in the DVI Standard Revision 1.0 and the HDMI Standard Revision 1.2a.

⁴ Typical value assumes only the selected HDMI/DVI link is active with nominal signal swings and that the unselected HDMI/DVI link is deactivated. Minimum and maximum limits are measured at the respective extremes of input termination resistance and input voltage swing.

⁵ The AD8190 is an I²C slave and its serial control interface is based on the 3.3 V I²C bus specification.

ABSOLUTE MAXIMUM RATINGS

Table 2.

| Parameter | Rating |
|---------------------------------------|--|
| AVCC to AVEE | 3.7 V |
| DVCC to DVEE | 3.7 V |
| DVEE to AVEE | ±0.3 V |
| VTTI | AVCC + 0.6 V |
| VTTO | AVCC + 0.6 V |
| AMUXVCC | 5.5 V |
| Internal Power Dissipation | 4.62 W |
| High Speed Input Voltage | AVCC – 1.4 V < V _{IN} < AVCC + 0.6 V |
| High Speed Differential Input Voltage | 2.0 V |
| Low Speed Input Voltage | DVEE – 0.3 V < V _{IN} < AMUXVCC + 0.6 V |
| I ² C Logic Input Voltage | DVEE – 0.3 V < V _{IN} < DVCC + 0.6 V |
| Storage Temperature Range | –65°C to +125°C |
| Operating Temperature Range | –40°C to +85°C |
| Junction Temperature | 150°C |

Stresses above those listed under Absolute Maximum Ratings may cause permanent damage to the device. This is a stress rating only; functional operation of the device at these or any other conditions above those indicated in the operational section of this specification is not implied. Exposure to absolute maximum rating conditions for extended periods may affect device reliability.

ESD CAUTION

ESD (electrostatic discharge) sensitive device. Electrostatic charges as high as 4000 V readily accumulate on the human body and test equipment and can discharge without detection. Although this product features proprietary ESD protection circuitry, permanent damage may occur on devices subjected to high energy electrostatic discharges. Therefore, proper ESD precautions are recommended to avoid performance degradation or loss of functionality.



THERMAL RESISTANCE

θ_{JA} is specified for the worst-case conditions: a device soldered in a 4-layer JEDEC circuit board for surface-mount packages.

θ_{JC} is specified for the exposed pad soldered to the circuit board with no airflow.

Table 3. Thermal Resistance

| Package Type | θ_{JA} | θ_{JC} | Unit |
|---------------|---------------|---------------|------|
| 56-Lead LFCSP | 27 | 2.1 | °C/W |

MAXIMUM POWER DISSIPATION

The maximum power that can be safely dissipated by the AD8190 is limited by the associated rise in junction temperature. The maximum safe junction temperature for plastic encapsulated devices is determined by the glass transition temperature of the plastic, approximately 150°C. Temporarily exceeding this limit may cause a shift in parametric performance due to a change in the stresses exerted on the die by the package. Exceeding a junction temperature of 175°C for an extended period can result in device failure. To ensure proper operation, it is necessary to observe the maximum power derating as determined by the coefficients in Table 3.

PIN CONFIGURATION AND FUNCTION DESCRIPTIONS

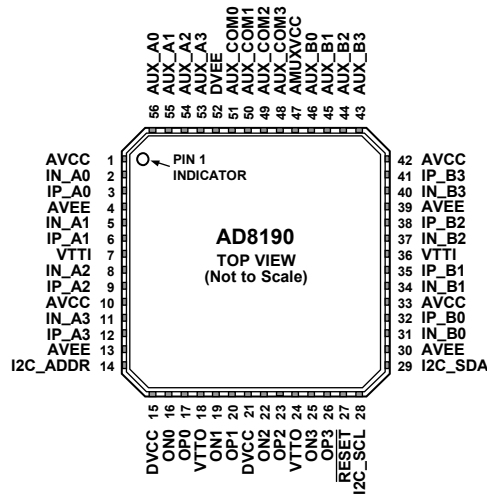

NOTES

1. THE AD8190 LFCSP HAS AN EXPOSED PADDLE (ePAD) ON THE UNDERSIDE OF THE PACKAGE WHICH AIDS IN HEAT DISSIPATION. THE ePAD MUST BE ELECTRICALLY CONNECTED TO THE AVEE SUPPLY PLANE IN ORDER TO MEET THERMAL SPECIFICATIONS.

08122-003

Figure 3. Pin Configuration

Table 4. Pin Function Descriptions

| Pin No. | Mnemonic | Type ¹ | Description |
|---------------------|----------|-------------------|--|
| 1, 10, 33, 42 | AVCC | Power | Positive Analog Supply. 3.3 V nominal. |
| 2 | IN_A0 | HS I | High Speed Input Complement. |
| 3 | IP_A0 | HS I | High Speed Input. |
| 4, 13, 30, 39, ePAD | AVEE | Power | Negative Analog Supply. 0 V nominal. |
| 5 | IN_A1 | HS I | High Speed Input Complement. |
| 6 | IP_A1 | HS I | High Speed Input. |
| 7, 36 | VTTI | Power | Input Termination Supply. Nominally connected to AVCC. |
| 8 | IN_A2 | HS I | High Speed Input Complement. |
| 9 | IP_A2 | HS I | High Speed Input. |
| 11 | IN_A3 | HS I | High Speed Input Complement. |
| 12 | IP_A3 | HS I | High Speed Input. |
| 14 | I2C_ADDR | Control | I ² C Address LSB. |
| 15, 21 | DVCC | Power | Positive Digital Power Supply. 3.3 V nominal. |
| 16 | ON0 | HS O | High Speed Output Complement. |
| 17 | OP0 | HS O | High Speed Output. |
| 18, 24 | VTTO | Power | Output Termination Supply. Nominally connected to AVCC. |
| 19 | ON1 | HS O | High Speed Output Complement. |
| 20 | OP1 | HS O | High Speed Output. |
| 22 | ON2 | HS O | High Speed Output Complement. |
| 23 | OP2 | HS O | High Speed Output. |
| 25 | ON3 | HS O | High Speed Output Complement. |
| 26 | OP3 | HS O | High Speed Output. |
| 27 | RESET | Control | Configuration Registers Reset. This pin is normally pulled up to DVCC. |
| 28 | I2C_SCL | Control | I ² C Clock. |
| 29 | I2C_SDA | Control | I ² C Data. |
| 31 | IN_B0 | HS I | High Speed Input Complement. |
| 32 | IP_B0 | HS I | High Speed Input. |

| Pin No. | Mnemonic | Type ¹ | Description |
|---------|----------|-------------------|--|
| 34 | IN_B1 | HS I | High Speed Input Complement. |
| 35 | IP_B1 | HS I | High Speed Input. |
| 37 | IN_B2 | HS I | High Speed Input Complement. |
| 38 | IP_B2 | HS I | High Speed Input. |
| 40 | IN_B3 | HS I | High Speed Input Complement. |
| 41 | IP_B3 | HS I | High Speed Input. |
| 43 | AUX_B3 | LS I/O | Low Speed Input/Output. |
| 44 | AUX_B2 | LS I/O | Low Speed Input/Output. |
| 45 | AUX_B1 | LS I/O | Low Speed Input/Output. |
| 46 | AUX_B0 | LS I/O | Low Speed Input/Output. |
| 47 | AMUXVCC | Power | Positive Auxiliary Switch Supply. 5 V typical. |
| 48 | AUX_COM3 | LS I/O | Low Speed Common Input/Output. |
| 49 | AUX_COM2 | LS I/O | Low Speed Common Input/Output. |
| 50 | AUX_COM1 | LS I/O | Low Speed Common Input/Output. |
| 51 | AUX_COM0 | LS I/O | Low Speed Common Input/Output. |
| 52 | DVEE | Power | Negative Digital and Auxiliary Switch Power Supply. 0 V nominal. |
| 53 | AUX_A3 | LS I/O | Low Speed Input/Output. |
| 54 | AUX_A2 | LS I/O | Low Speed Input/Output. |
| 55 | AUX_A1 | LS I/O | Low Speed Input/Output. |
| 56 | AUX_A0 | LS I/O | Low Speed Input/Output. |

¹ HS = high speed, LS = low speed, I = input, O = output.

TYPICAL PERFORMANCE CHARACTERISTICS

$T_A = 27^\circ\text{C}$, $AVCC = 3.3\text{ V}$, $V_{TTI} = 3.3\text{ V}$, $V_{TTO} = 3.3\text{ V}$, $DVCC = 3.3\text{ V}$, $AMUXVCC = 5\text{ V}$, $AVEE = 0\text{ V}$, $DVEE = 0\text{ V}$, differential input swing = 1000 mV , TMDs outputs terminated with external $50\ \Omega$ resistors to 3.3 V , pattern = PRBS $2^7 - 1$, data rate = 1.65 Gbps , unless otherwise noted.

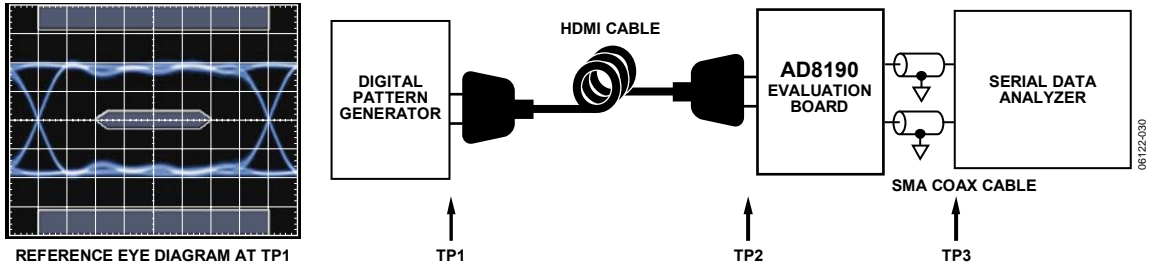

Figure 4. Test Circuit Diagram for RX Eye Diagrams

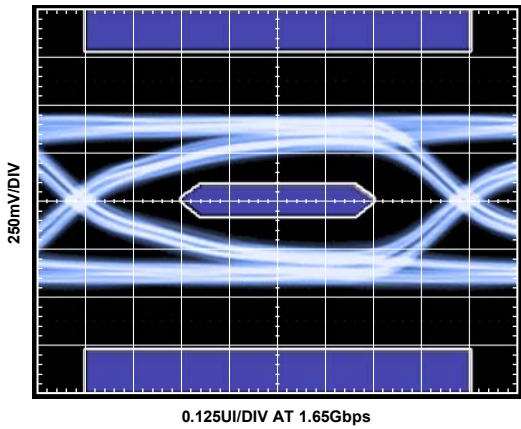

Figure 5. RX Eye Diagram at TP2 (Cable = 2 m, 30 AWG)

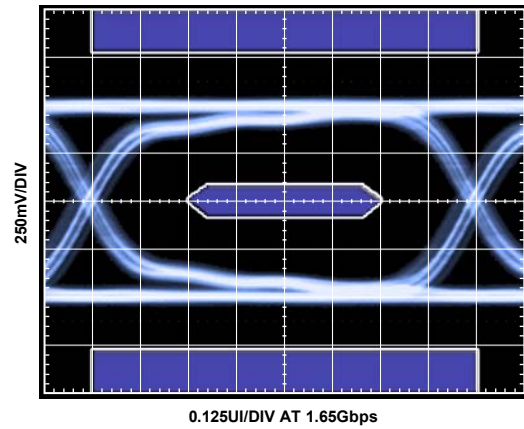

Figure 7. RX Eye Diagram at TP3, EQ = 6 dB (Cable = 2 m, 30 AWG)

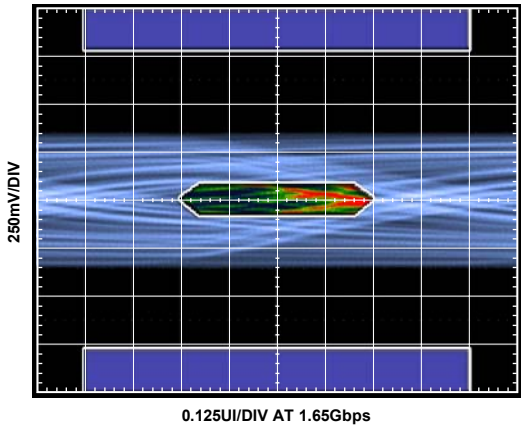

Figure 6. RX Eye Diagram at TP2 (Cable = 20 m, 24 AWG)

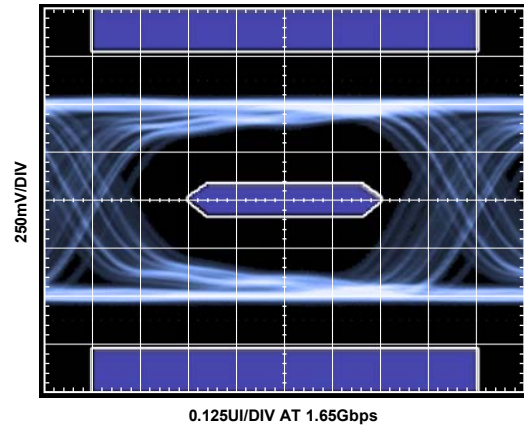

Figure 8. RX Eye Diagram at TP3, EQ = 12 dB (Cable = 20 m, 24 AWG)

$T_A = 27^\circ\text{C}$, $AVCC = 3.3\text{ V}$, $VTTI = 3.3\text{ V}$, $VTTO = 3.3\text{ V}$, $DVCC = 3.3\text{ V}$, $AMUXVCC = 5\text{ V}$, $AVEE = 0\text{ V}$, $DVEE = 0\text{ V}$, differential input swing = 1000 mV, TMDS outputs terminated with external $50\ \Omega$ resistors to 3.3 V, pattern = PRBS $2^7 - 1$, data rate = 1.65 Gbps, unless otherwise noted.

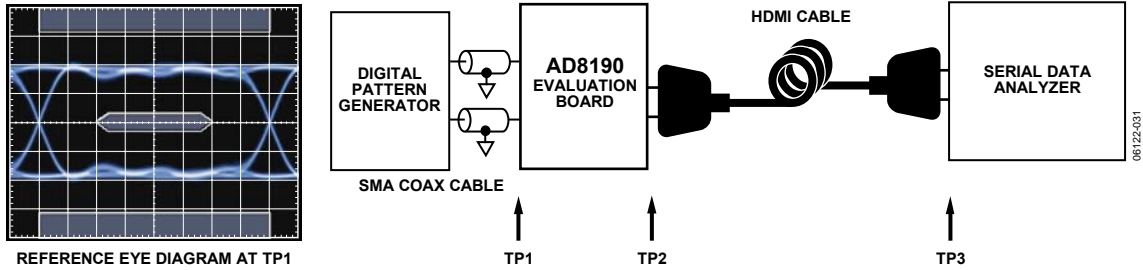

Figure 9. Test Circuit Diagram for TX Eye Diagram

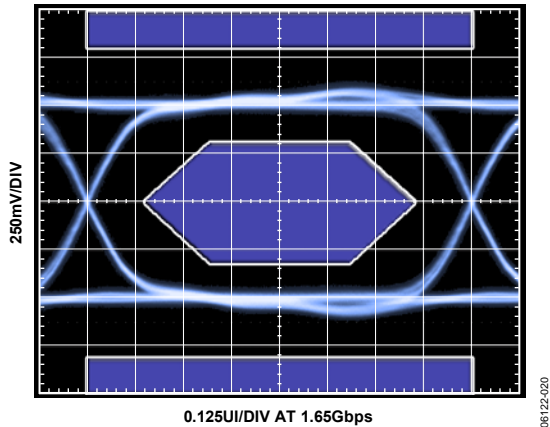

Figure 10. TX Eye Diagram at TP2, PE = 2 dB

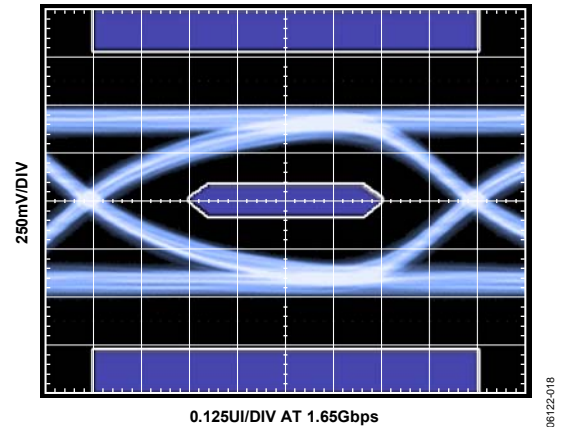

Figure 12. TX Eye Diagram at TP3, PE = 2 dB (Cable = 2 m, 30 AWG)

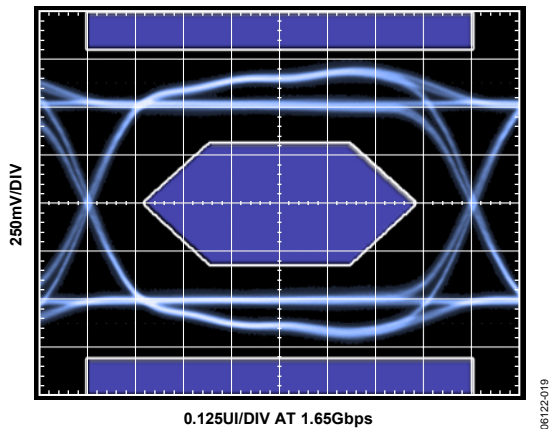

Figure 11. TX Eye Diagram at TP2, PE = 6 dB

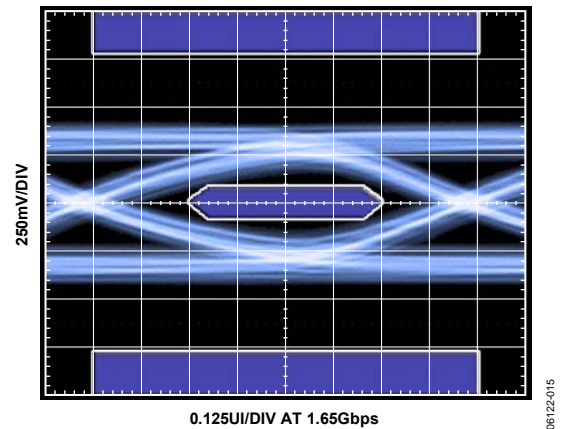

Figure 13. TX Eye Diagram at TP3, PE = 6 dB (Cable = 10 m, 28 AWG)

$T_A = 27^\circ\text{C}$, $AVCC = 3.3\text{ V}$, $V_{TTI} = 3.3\text{ V}$, $V_{TTO} = 3.3\text{ V}$, $DVCC = 3.3\text{ V}$, $AMUXVCC = 5\text{ V}$, $AVEE = 0\text{ V}$, $DVEE = 0\text{ V}$, differential input swing = 1000 mV , TMDS outputs terminated with external $50\ \Omega$ resistors to 3.3 V , pattern = PRBS $2^7 - 1$, data rate = 1.65 Gbps , unless otherwise noted.

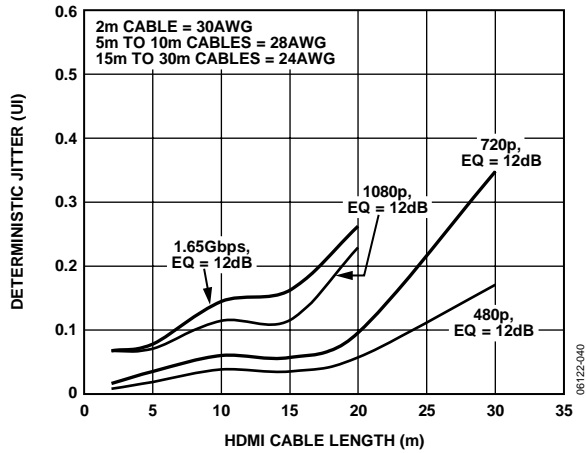

Figure 14. Jitter vs. Input Cable Length (See Figure 4 for Test Setup)

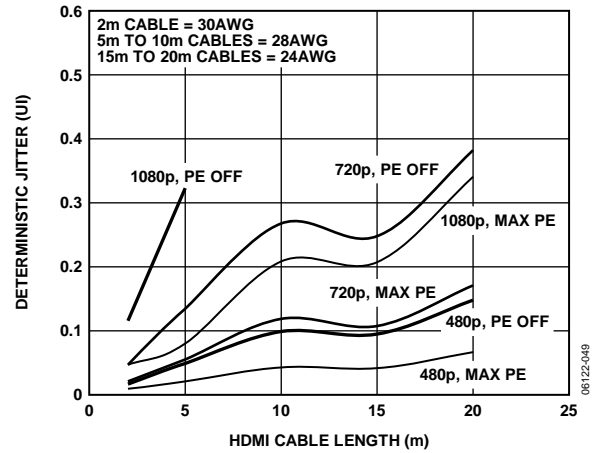

Figure 17. Jitter vs. Output Cable Length (See Figure 9 for Test Setup)

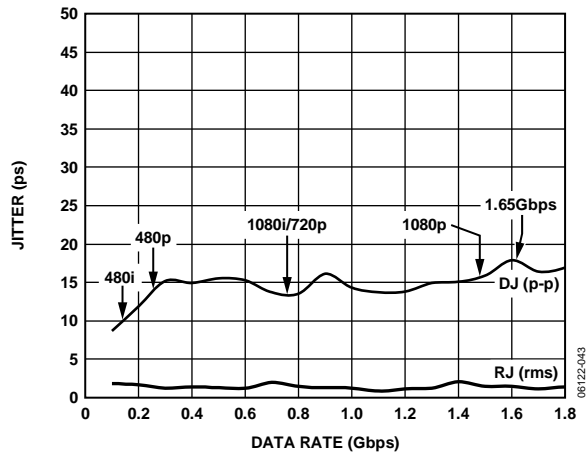

Figure 15. Jitter vs. Data Rate

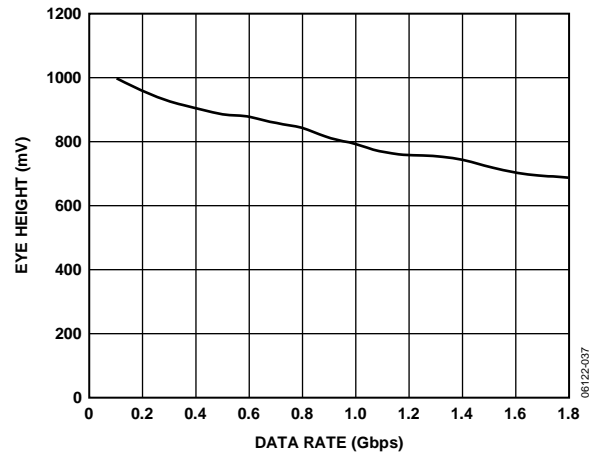

Figure 18. Eye Height vs. Data Rate

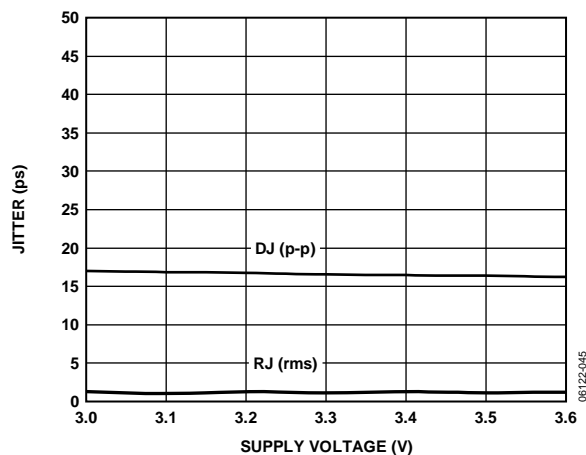

Figure 16. Jitter vs. Supply Voltage

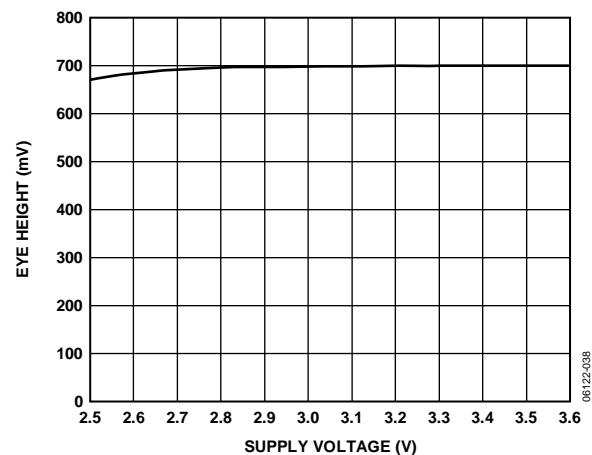

Figure 19. Eye Height vs. Supply Voltage

$T_A = 27^\circ\text{C}$, $AVCC = 3.3\text{ V}$, $V_{TTI} = 3.3\text{ V}$, $V_{TTO} = 3.3\text{ V}$, $DVCC = 3.3\text{ V}$, $AMUXVCC = 5\text{ V}$, $AVEE = 0\text{ V}$, $DVEE = 0\text{ V}$, differential input swing = 1000 mV, TMDs outputs terminated with external $50\ \Omega$ resistors to 3.3 V, pattern = PRBS $2^7 - 1$, data rate = 1.65 Gbps, unless otherwise noted.

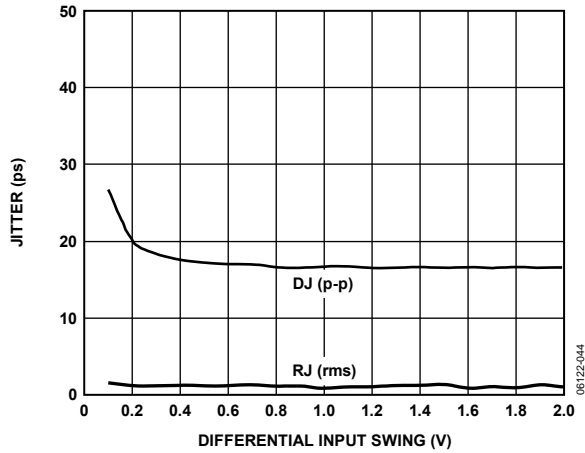

Figure 20. Jitter vs. Differential Input Swing

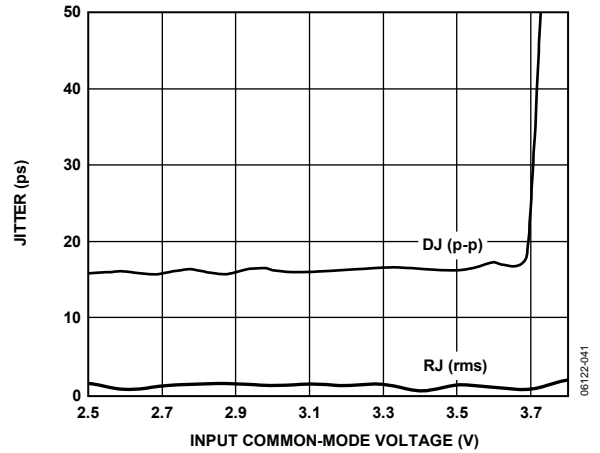

Figure 23. Jitter vs. Input Common-Mode Voltage

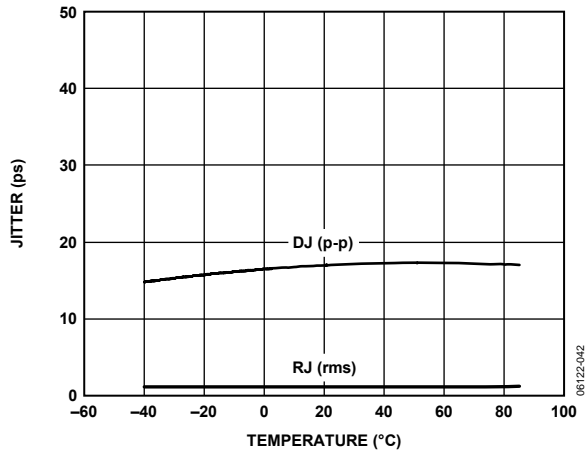

Figure 21. Jitter vs. Temperature

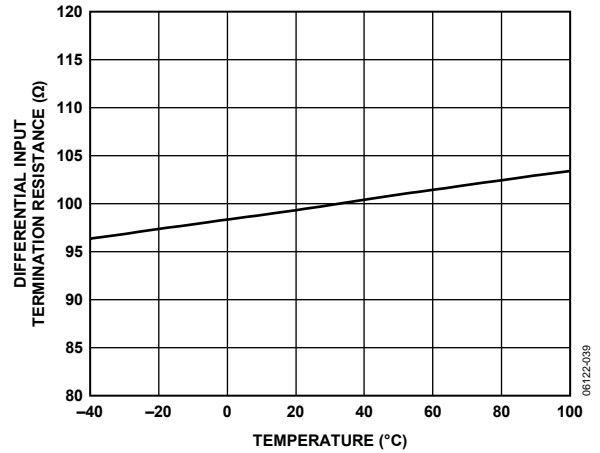

Figure 24. Differential Input Termination Resistance vs. Temperature

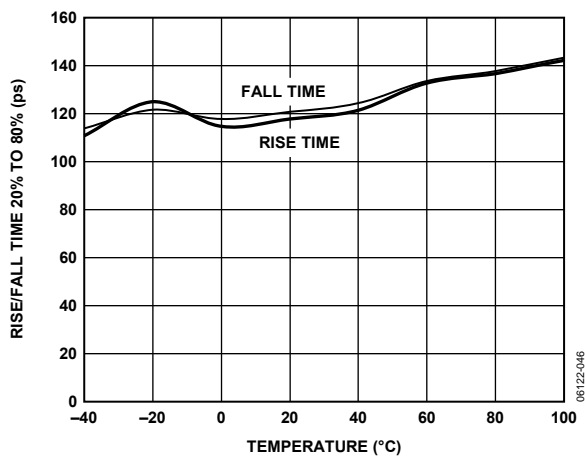

Figure 22. Rise and Fall Time vs. Temperature

THEORY OF OPERATION

INTRODUCTION

The primary function of the AD8190 is to switch one of two (DVI or HDMI) single-link sources to one output. Each HDMI/DVI link consists of four differential, high speed channels and four auxiliary single-ended, low speed control signals. The high speed channels include a data-word clock and three transition minimized differential signaling (TMDS) data channels running at 10× the data-word clock frequency for data rates up to 1.65 Gbps. The four low speed control signals are 5 V tolerant bidirectional lines that can carry configuration signals, HDCP encryption, and other information, depending upon the specific application.

All four high speed TMDS channels are identical; that is, the pixel clock can be run on any of the four TMDS channels.

Transmit and receive channel compensation is provided for the high speed channels where the user can (manually) select among a number of fixed settings.

The AD8190 has I²C serial programming with two user programmable I²C slave addresses. The I²C slave address of the AD8190 is 0b100100X. The least significant bit, represented by X in the address, is set by tying the I2C_ADDR pin to either 3.3 V (for the value, X = 1) or to 0 V (for X = 0).

INPUT CHANNELS

Each high speed input differential pair terminates to the 3.3 V VTTI power supply through a pair of single-ended 50 Ω on-chip resistors, as shown in Figure 25. The input terminations can be optionally disconnected for approximately 100 ms following a source switch. The user can program which of the eight high speed input channels employs this feature by selectively setting the associated RX_PT bits in the input termination pulse register. Additionally, all the input terminations can be disconnected by programming the RX_TO bit in the receiver settings register.

The input equalizer can be manually configured to provide two different levels of high frequency boost: 6 dB or 12 dB. The user can individually program the equalization level of the eight high speed input channels by selectively setting the associated RX_EQ bits in the receive equalizer register. No specific cable length is suggested for a particular equalization setting because cable performance varies widely between manufacturers; however, in general, the equalization of the AD8190 can be set to 12 dB without degrading the signal integrity, even for short input cables. At the 12 dB setting, the AD8190 can equalize up to 20 meters of 24 AWG cable at 1080p, over reference cables that exhibit an insertion loss of -15 dB.

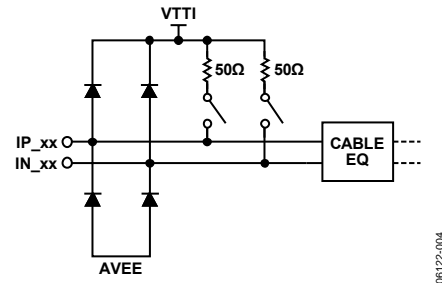

Figure 25. High Speed Input Simplified Schematic

OUTPUT CHANNELS

Each high speed output differential pair is terminated to the 3.3 V VTTO power supply through two single-ended 50 Ω on-chip resistors (see Figure 26). This output termination is user-selectable; all the output terminations can be turned on or off by programming the TX_PTO bit of the transmitter settings register.

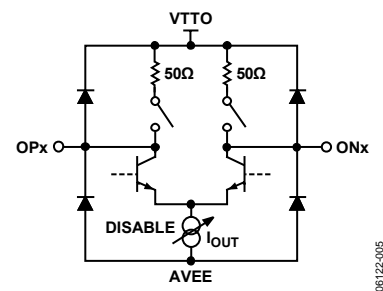

Figure 26. High Speed Output Simplified Schematic

The AD8190 output has a disable feature that places the outputs in a tristate mode. This mode is enabled by setting the HS_EN bit of the high speed device modes register. Larger wire-ORed arrays can be constructed using the AD8190 in this mode.

The AD8190 requires output termination resistors when the high speed outputs are enabled. Termination can be internal and/or external. The internal terminations of the AD8190 are enabled by setting the TX_PTO bit of the transmitter settings register (the default upon reset). External terminations can be provided either by on-board resistors or by the input termination resistors of an HDMI/DVI receiver. If both internal and external terminations are provided, set the output current level to 20 mA by programming the TX_OCL bit of the transmitter settings register (the default upon reset). If only external terminations are provided, set the output current level to 10 mA. The high speed outputs must be disabled if there are no output termination resistors present in the system.

The output pre-emphasis can be manually configured to provide one of four different levels of high frequency boost. The specific boost level is selected by programming the TX_PE bits of the transmitter settings register. No specific cable length is suggested for a particular pre-emphasis setting because cable performance varies widely between manufacturers.

SWITCHING MODE

The AD8190 behaves like a 2:1 HDMI/DVI switch by implementing a quad switching mode. In this mode, the user selects the high speed source (A or B) that is routed to the output by programming the HS_CH bit of the high speeds modes register as shown in Table 7. The low speed auxiliary source (AUX_A or AUX_B) that is routed to the common output is separately set by programming the AUX_CH bit of the auxiliary device register as shown in Table 9.

AUXILIARY LINES SWITCHING

The auxiliary (low speed) lines have no amplification. They are routed using a passive switch that is bandwidth compatible with standard speed I²C. The schematic equivalent for this passive connection is shown in Figure 27.

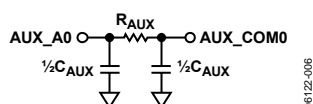

Figure 27. Auxiliary Channel Simplified Schematic Showing AUX_A0 to AUX_COM0 Routing

When turning off the AD8190, care needs to be taken with the AMUXVCC supply to ensure that the auxiliary multiplexer pins are in a high impedance state. A scenario that illustrates this requirement is one where the auxiliary multiplexer is used to switch the display data channel (DDC) bus. In some applications, additional devices can be connected to the DDC bus (such as an EEPROM with EDID information) upstream of the AD8190. Extended display identification data (EDID) is a VESA standard-defined data format for conveying display configuration

information to sources to optimize display use. EDID devices may need to be available via the DDC bus, regardless of the state of the AD8190 and any downstream circuit. For this configuration, the auxiliary inputs of the powered down AD8190 need to be in a high impedance state to avoid pulling down on the DDC lines and preventing these other devices from using the bus.

When the AD8190 is powered from a simple resistor network, as shown in Figure 28, it uses the 5 V supply that is required from any HDMI/DVI source to guarantee high impedance of the auxiliary multiplexer pins. The AMUXVCC supply does not draw any static current; therefore, it is recommended that the resistor network tap the 5 V supplies as close to the connectors as possible to avoid any additional voltage drop.

This precaution does not need to be taken if the DDC peripheral circuitry is connected to the bus downstream of the AD8190.

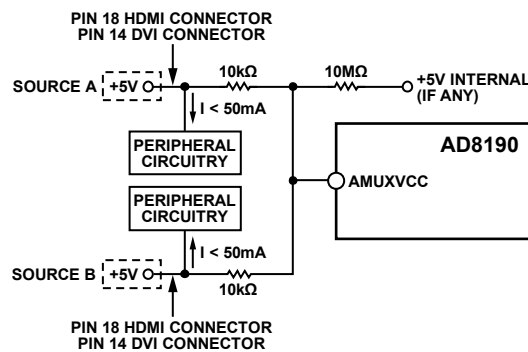

Figure 28. Suggested AMUXVCC Power Scheme

SERIAL CONTROL INTERFACE

RESET

On initial power-up, or at any point in operation, the AD8190 register set can be restored to the default values by pulling the RESET pin to low according to the specification in Table 1.

During normal operation, however, the RESET pin must be pulled up to 3.3 V. Pulling the RESET pin to low sets the HS_CH register to 0 (Input A) and incurs the associated switching delay before the input can be switched to Input B, regardless of the previous state of the AD8190.

WRITE PROCEDURE

To write data to the AD8190 register set, an I²C master (such as a microcontroller) needs to send the appropriate control signals to the AD8190 slave device. The signals are controlled by the I²C master unless otherwise specified. For a diagram of the procedure, see Figure 29. The steps for a write procedure are as follows:

1. Send a start condition (while holding the I2C_SCL line high, pull the I2C_SDA line low).
2. Send the AD8190 part address (seven bits). The upper six bits of the AD8190 part address are the static value [100100] and the LSB is set by Input Pin I2C_ADDR. This transfer should be MSB first.
3. Send the write indicator bit (0).
4. Wait for the AD8190 to acknowledge the request.
5. Send the register address (eight bits) to which data is to be written. This transfer should be MSB first.
6. Wait for the AD8190 to acknowledge the request.
7. Send the data (eight bits) to be written to the register whose address was set in Step 5. This transfer should be MSB first.
8. Wait for the AD8190 to acknowledge the request.
9. Do one of the following:
 - a. Send a stop condition (while holding the I2C_SCL line high, pull the I2C_SDA line high) and release control of the bus to end the transaction (shown in Figure 29).
 - b. Send a repeated start condition (while holding the I2C_SCL line high, pull the I2C_SDA line low) and continue with Step 2 in this procedure to perform another write.
 - c. Send a repeated start condition (while holding the I2C_SCL line high, pull the I2C_SDA line low) and continue with Step 2 of the read procedure (in the Read Procedure section) to perform a read from another address.
 - d. Send a repeated start condition (while holding the I2C_SCL line high, pull the I2C_SDA line low) and continue with Step 8 of the read procedure (in the Read Procedure section) to perform a read from the same address set in Step 5.

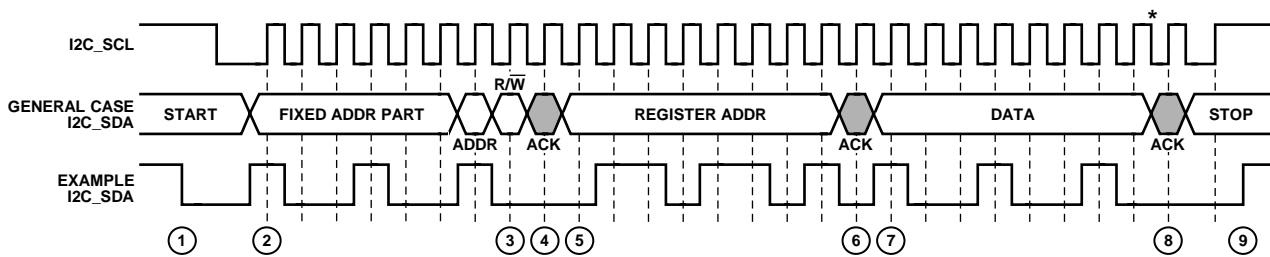

*THE SWITCHING/UPDATE DELAY BEGINS AT THE FALLING EDGE OF THE LAST DATA BIT; FOR EXAMPLE, THE FALLING EDGE JUST BEFORE STEP 8.

Figure 29. I²C Write Procedure

0612Z-008

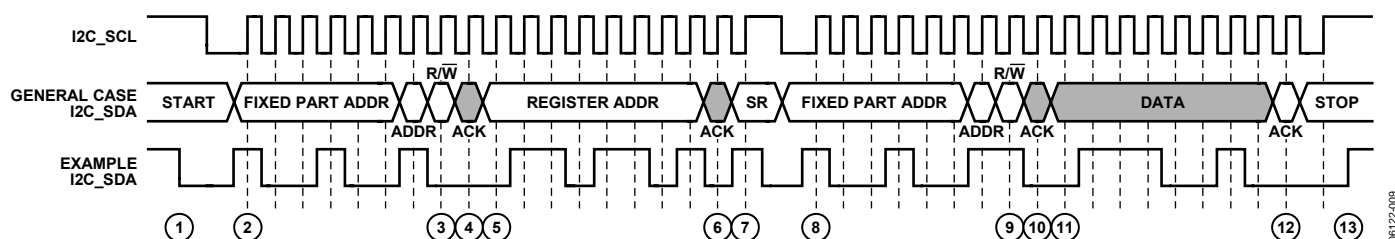
Figure 30. I²C Read Procedure

READ PROCEDURE

To read data from the AD8190 register set, an I²C master (such as a microcontroller) needs to send the appropriate control signals to the AD8190 slave device. The signals are controlled by the I²C master unless otherwise specified. For a diagram of the procedure, see Figure 30. The steps for a read procedure are as follows:

1. Send a start condition (while holding the I2C_SCL line high, pull the I2C_SDA line low).
2. Send the AD8190 part address (seven bits). The upper six bits of the AD8190 part address are the static value [100100] and the LSB is set by Input Pin I2C_ADDR. This transfer should be MSB first.
3. Send the write indicator bit (0).
4. Wait for the AD8190 to acknowledge the request.
5. Send the register address (eight bits) from which data is to be read. This transfer should be MSB first.
6. Wait for the AD8190 to acknowledge the request.
7. Send a repeated start condition (Sr) by holding the I2C_SCL line high and pulling the I2C_SDA line low.
8. Resend the AD8190 part address (seven bits) from Step 2. The upper six bits of the AD8190 part address compose the static value [100100]. The LSB is set by Input Pin I2C_ADDR. This transfer should be MSB first.
9. Send the read indicator bit (1).
10. Wait for the AD8190 to acknowledge the request.
11. The AD8190 serially transfers the data (eight bits) held in the register indicated by the address set in Step 5. This data is sent MSB first.
12. Acknowledge the data from the AD8190.
13. Do one of the following:
 - a. Send a stop condition (while holding the I2C_SCL line high, pull the SDA line high) and release control of the bus to end the transaction (shown in Figure 30).
 - b. Send a repeated start condition (while holding the I2C_SCL line high, pull the I2C_SDA line low) and continue with Step 2 of the write procedure (see the previous Write Procedure section) to perform a write.
 - c. Send a repeated start condition (while holding the I2C_SCL line high, pull the I2C_SDA line low) and continue with Step 2 of this procedure to perform a read from another address.
 - d. Send a repeated start condition (while holding the I2C_SCL line high, pull the I2C_SDA line low) and continue with Step 8 of this procedure to perform a read from the same address.

SWITCHING/UPDATE DELAY

There is a delay between when a user writes to the configuration registers of the AD8190 and when that state change takes physical effect. This update delay begins at the falling edge of I2C_SCL for the last data bit transferred, as shown in Figure 29. This update delay is register specific and the times are specified in Table 1.

During a delay window, new values can be written to the configuration registers but the AD8190 does not physically update until the end of that register's delay window. Writing new values during the delay window does not reset the window; new values supersede the previously written values. At the end of the delay window, the AD8190 physically assumes the state indicated by the last set of values written to the configuration registers. If the configuration registers are written after the delay window ends, the AD8190 immediately updates and a new delay window begins.

CONFIGURATION REGISTERS

The serial interface configuration registers can be read and written using the I²C serial interface, Pin I2C_SDA, and Pin I2C_SCL. The LSB of the AD8190 I²C part address is set by tying Pin I2C_ADDR to 3.3 V (I2C_ADDR = 1) or 0 V (I2C_ADDR = 0).

Table 5. Register Map

| Name | Bit 7 | Bit 6 | Bit 5 | Bit 4 | Bit 3 | Bit 2 | Bit 1 | Bit 0 | Addr. | Default |
|-------------------------|---|---------------------------------------|----------|----------|---|----------|--------------------------------------|--|-------|---------|
| High Speed Device Modes | | High speed switch enable HS_EN | | | | | | High speed source select HS_CH | 0x00 | 0x40 |
| Auxiliary Device Modes | | Auxiliary switch enable AUX_EN | | | | | | Auxiliary switch source select AUX_CH | 0x01 | 0x40 |
| Receiver Settings | | | | | | | | High speed input termination select RX_TO | 0x10 | 0x01 |
| Input Termination Pulse | Input termination pulse-on-source-switch select (disconnect termination for a short period of time) | | | | | | | | 0x11 | 0x00 |
| | RX_PT[7] | RX_PT[6] | RX_PT[5] | RX_PT[4] | RX_PT[3] | RX_PT[2] | RX_PT[1] | RX_PT[0] | | |
| Receive Equalizer | Input equalization level select | | | | | | | | 0x13 | 0x00 |
| | RX_EQ[7] | RX_EQ[6] | RX_EQ[5] | RX_EQ[4] | RX_EQ[3] | RX_EQ[2] | RX_EQ[1] | RX_EQ[0] | | |
| Transmitter Settings | | | | | High speed output pre-emphasis level select | | High speed output termination select | High speed output current level select | 0x20 | 0x03 |
| | | | | | TX_PE[1] | TX_PE[0] | TX_PTO | TX_OCL | | |

HIGH SPEED DEVICE MODES REGISTER

HS_EN: High Speed (TMDS) Switch Enable Bit

Table 6. HS_EN Description

| HS_EN | Description |
|-------|---|
| 0 | High speed channels off, low power/standby mode |
| 1 | High speed channels on |

HS_CH: High Speed (TMDS) Source Select Bit

Table 7. HS_CH Mapping

| HS_CH | O[3:0] | Description |
|-------|--------|--|
| 0 | A[3:0] | High speed Source A switched to output |
| 1 | B[3:0] | High speed Source B switched to output |

AUXILIARY DEVICE MODES REGISTER

AUX_EN: Auxiliary (Low Speed) Switch Enable Bit

Table 8. AUX_EN Description

| AUX_EN | Description |
|--------|---|
| 0 | Auxiliary switch off, no low speed input/output to low speed common input/output connection |
| 1 | Auxiliary switch on |

AUX_CH: Auxiliary (Low Speed) Switch Source Select Bit

Table 9. AUX_CH Mapping

| AUX_CH | AUX_COM[3:0] | Description |
|--------|--------------|---------------------------------------|
| 0 | AUX_A[3:0] | Auxiliary Source A switched to output |
| 1 | AUX_B[3:0] | Auxiliary Source B switched to output |

RECEIVER SETTINGS REGISTER***RX_TO: High Speed (TMDS) Input Termination On/Off Select Bit***

Table 10. RX_TO Description

| RX_TO | Description |
|-------|--|
| 0 | Input termination off |
| 1 | Input termination on (can be pulsed on and off when source is switched, according to settings in the input termination pulse register) |

INPUT TERMINATION PULSE REGISTER***RX_PT[X]: High Speed (TMDS) Input Termination X Pulse-On-Source Switch Select Bit***

Table 11. RX_PT[X] Description

| RX_PT[X] | Description |
|----------|--|
| 0 | Input termination for TMDS Channel X always connected when source is switched |
| 1 | Input termination for TMDS Channel X disconnected for approximately 100 ms when source is switched |

Table 12. RX_PT[X] Mapping

| RX_PT[X] | Corresponding Input TMDS Channel |
|----------|----------------------------------|
| Bit 0 | A0 |
| Bit 1 | A1 |
| Bit 2 | A2 |
| Bit 3 | A3 |
| Bit 4 | B3 |
| Bit 5 | B2 |
| Bit 6 | B1 |
| Bit 7 | B0 |

RECEIVE EQUALIZER REGISTER***RX_EQ[X]: High Speed (TMDS) Input X Equalization Level Select Bit***

Table 13. RX_EQ[X] Description

| RX_EQ[X] | Description |
|----------|---------------------------|
| 0 | Low equalization (6 dB) |
| 1 | High equalization (12 dB) |

Table 14. RX_EQ[X] Mapping

| RX_EQ[X] | Corresponding Input TMDS Channel |
|----------|----------------------------------|
| Bit 0 | A0 |
| Bit 1 | A1 |
| Bit 2 | A2 |
| Bit 3 | A3 |
| Bit 4 | B3 |
| Bit 5 | B2 |
| Bit 6 | B1 |
| Bit 7 | B0 |

TRANSMITTER SETTINGS REGISTER***TX_PE[1:0]: High Speed (TMDS) Output Pre-Emphasis Level Select Bus (All TMDS Channels)***

Table 15. TX_PE[1:0] Description

| TX_PE[1:0] | Description |
|------------|----------------------------|
| 00 | No pre-emphasis (0 dB) |
| 01 | Low pre-emphasis (2 dB) |
| 10 | Medium pre-emphasis (4 dB) |
| 11 | High pre-emphasis (6 dB) |

X_PTO: High Speed (TMDS) Output Termination On/Off Select Bit (All Channels)

Table 16. TX_PTO Description

| TX_PTO | Description |
|--------|------------------------|
| 0 | Output termination off |
| 1 | Output termination on |

TX_OCL: High Speed (TMDS) Output Current Level Select Bit (All Channels)

Table 17. TX_OCL Description

| TX_OCL | Description |
|--------|-----------------------------|
| 0 | Output current set to 10 mA |
| 1 | Output current set to 20 mA |

APPLICATION NOTES

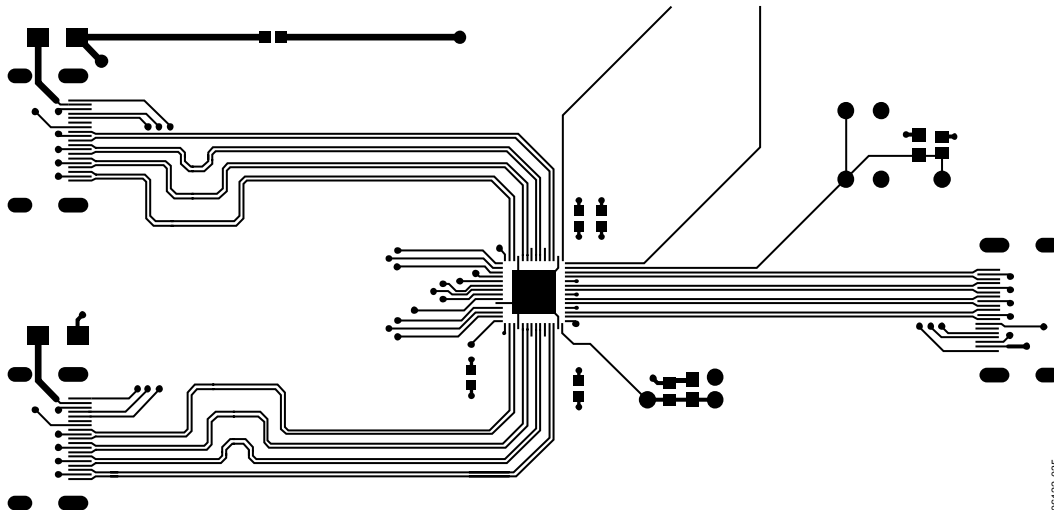

Figure 31. Evaluation Board Layout of the TMDS Traces

The AD8190 is an HDMI/DVI switch featuring equalized TMDS inputs and pre-emphasized TMDS outputs. It is intended for use as a 2:1 switch in systems with long cable runs on both the input and/or the output, and is fully HDMI 1.2a receive compliant.

PINOUT

The AD8190 was designed to have an HDMI/DVI receiver pinout at its input and a transmitter pinout at its output. This makes the AD8190 ideal for use in AVR-type applications where a designer routes both the inputs and the outputs directly to HDMI/DVI connectors as shown in Figure 31. When the AD8190 is used in receiver-type applications, it is necessary to change the ordering of the output pins on the PCB to match up with the on-board receiver, as shown in Figure 32.

One advantage of the AD8190 in an AVR-type application is that all of the high speed signals can be routed on one side (the topside) of the board, as shown in Figure 31. In addition to 12 dB of input equalization, the AD8190 provides up to 6 dB of output pre-emphasis that boosts the output TMDS signals and allows the AD8190 to precompensate when driving long PCB traces or output cables. The net effect of the input equalization and output pre-emphasis of the AD8190 is that the AD8190 can compensate for the signal degradation of both input and output cables; it acts to reopen a closed input data eye and transmit a full-swing HDMI signal to an end receiver. More information on the specific performance metrics of the AD8190 can be found in the Typical Performance Characteristics section.

The AD8190 also provides a distinct advantage in receive-type applications because it is a fully buffered HDMI/DVI switch.

Although inverting the output pin order of the AD8190 on the PCB requires a designer to place vias in the high speed signal path, the AD8190 fully buffers and electrically decouples the outputs from the inputs. Therefore, the effects of the vias placed on the output signal lines are not seen at the input of the AD8190. The programmable output terminations also improve signal quality at the output of the AD8190. The PCB designer, therefore, has significantly improved flexibility in the placement and routing of the output signal path with the AD8190 over other solutions.

An example of high speed routing from an HDMI Standard Revision 1.2a receive-compliant reference design is shown in Figure 32. The light gray TMDS lines are routed on the top layer of the PCB, the dark gray TMDS lines are routed on the bottom layer, and the black dots are vias.

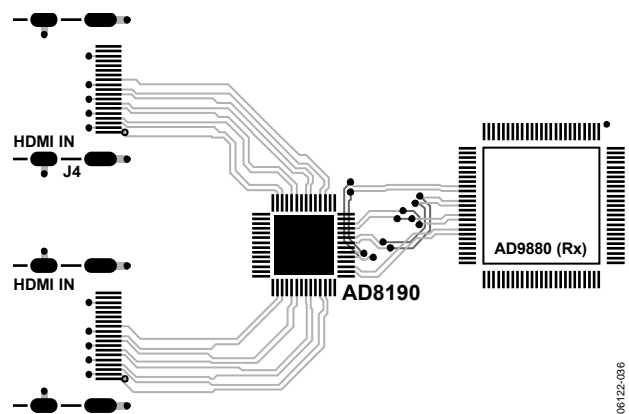

Figure 32. Layout of the TMDS Traces for the AD8190 in an HDMI Standard Revision 1.2a Receive-Compliant Reference Design

CABLE LENGTHS AND EQUALIZATION

The AD8190 offers two levels of programmable equalization for the high speed inputs: 6 dB and 12 dB. The equalizer of the AD8190 is optimized for video data rates of 1.65 Gbps, and as shown in Figure 14, it can equalize up to 20 meters of 24 AWG HDMI cable at data rates corresponding to the video format, 1080p.

The length of cable that can be used in a typical HDMI/DVI application depends on a large number of factors including:

- Cable quality: the quality of the cable in terms of conductor wire gauge and shielding. Thicker conductors have lower signal degradation per unit length.
- Data rate: the data rate being sent over the cable. The signal degradation of HDMI cables increases with data rate.
- Edge rates: the edge rates of the source input. Slower input edges result in more significant data eye closure at the end of a cable.
- Receiver sensitivity: the sensitivity of the terminating receiver.

As such, specific cable types and lengths are not recommended for use with a particular equalizer setting. In nearly all applications, the AD8190 equalization level can be set to high, or 12 dB, for all input cable configurations at all data rates, without degrading the signal integrity.

THE AD8190 AS A SINGLE-CHANNEL BUFFER

The AD8190 can be used as a single-channel TMDS buffer without the need for any external I²C control. In its default configuration, the AD8190 connects both the high speed and low speed channels of Input A to their respective outputs, sets the input equalization level to 6 dB, the output pre-emphasis level to 0 dB, enables both the output and input terminations, and provides a fully functioning HDMI link with TMDS buffering.

The AD8190 enters this default state whenever the $\overline{\text{RESET}}$ pin is pulled to low in accordance with the specification in Table 1.

PCB LAYOUT GUIDELINES

The AD8190 is used to switch two distinctly different types of signals, both of which are required for HDMI and DVI video. These signal groups require different treatment when laying out a PC board.

The first group of signals carries the audiovisual (AV) data. HDMI/DVI video signals are differential, unidirectional, and high speed (up to 1.65 Gbps). The channels that carry the video data must be controlled impedance, terminated at the receiver, and capable of operating up to at least 1.65 Gbps. It is especially important to note that the differential traces that carry the TMDS signals should be designed with a controlled differential impedance of 100 Ω . The AD8190 provides single-ended 50 Ω

terminations on-chip for both its inputs and outputs, and both the input and output terminations can be enabled or disabled through the serial interface. Transmitter termination is not fully specified by the HDMI standard but its inclusion improves the overall system signal integrity.

The audiovisual (AV) data carried on these high speed channels is encoded by a technique called transition minimized differential signaling (TMDS) and in the case of HDMI, is also encrypted according to the high bandwidth digital copy protection (HDCP) standard.

The second group of signals consists of low speed auxiliary control signals used for communication between a source and a sink. Depending upon the application, these signals can include the DDC bus (this is an I²C bus used to send EDID information and HDCP encryption keys between the source and the sink), the consumer electronics control (CEC) line, and the hot plug detect (HPD) line. These auxiliary signals are bidirectional, low speed, and transferred over a single-ended transmission line that does not need to have controlled impedance. The primary concern with laying out the auxiliary lines is ensuring that they conform to the I²C bus standard and do not have excessive capacitive loading.

TMDS Signals

In the HDMI/DVI standard, four differential pairs carry the TMDS signals. In DVI, three of these pairs are dedicated to carrying RGB video and sync data. For HDMI, audio data is also interleaved with the video data; the DVI standard does not incorporate audio information. The fourth high speed differential pair is used for the AV data-word clock, and runs at one-tenth the speed of the TMDS data channels.

The four high speed channels of the AD8190 are identical. No concession was made to lower the bandwidth of the fourth channel for the pixel clock, so any channel can be used for any TMDS signal. The user chooses which signal is routed over which channel. Additionally, the TMDS channels are symmetrical; therefore, the p and n of a given differential pair are interchangeable, provided the inversion is consistent across all inputs and outputs of the AD8190. However, the routing between inputs and outputs through the AD8190 is fixed. For example, Output Channel 0 always switches between Input A0 and Input B0, and so forth.

The AD8190 buffers the TMDS signals and the input traces can be considered electrically independent of the output traces. In most applications, the quality of the signal on the input TMDS traces are more sensitive to the PCB layout. Regardless of the data being carried on a specific TMDS channel, or whether the TMDS line is at the input or the output of the AD8190, all four high speed signals should be routed on a PCB in accordance with the same RF layout guidelines.

Layout for the TMDS Signals

The TMDS differential pairs can either be microstrip traces, routed on the outer layer of a board, or stripline traces, routed on an internal layer of the board. If microstrip traces are used, there should be a continuous reference plane on the PCB layer directly below the traces. If stripline traces are used, they must be sandwiched between two continuous reference planes in the PCB stack-up. Additionally, the p and n of each differential pair must have a controlled differential impedance of 100 Ω . The characteristic impedance of a differential pair is a function of several variables including the trace width, the distance separating the two traces, the spacing between the traces and the reference plane, and the dielectric constant of the PC board binder material. Interlayer vias introduce impedance discontinuities that can cause reflections and jitter on the signal path, therefore, it is preferable to route the TMDS lines exclusively on one layer of the board, particularly for the input traces. Additionally, to prevent unwanted signal coupling and interference, route the TMDS signals away from other signals and noise sources on the PCB.

Both traces of a given differential pair must be equal in length to minimize intrapair skew. Maintaining the physical symmetry of a differential pair is integral to ensuring its signal integrity; excessive intrapair skew can introduce jitter through duty cycle distortion (DCD). The p and n of a given differential pair should always be routed together in order to establish the required 100 Ω differential impedance. Enough space should be left between the differential pairs of a given group so that the n of one pair does not couple to the p of another pair. For example, one technique is to make the interpair distance 4 to 10 times wider than the intrapair spacing.

Any group of four TMDS channels (Input A, Input B, or the output) should have closely matched trace lengths in order to minimize interpair skew. Severe interpair skew can cause the data on the four different channels of a group to arrive out of alignment with one another. A good practice is to match the trace lengths for a given group of four channels to within 0.05 inches on FR4 material.

The length of the TMDS traces should be minimized to reduce overall signal degradation. Commonly used PC board material such as FR4 is lossy at high frequencies, so long traces on the circuit board increase signal attenuation, resulting in decreased signal swing and increased jitter through intersymbol interference (ISI).

Controlling the Characteristic Impedance of a TMDS Differential Pair

The characteristic impedance of a differential pair depends on a number of variables including the trace width, the distance between the two traces, the height of the dielectric material between the trace and the reference plane below it, and the dielectric constant of the PCB binder material. To a lesser extent, the characteristic impedance also depends upon the trace thickness and the presence of solder mask.

There are many combinations that can produce the correct characteristic impedance. It is generally required to work with the PC board fabricator to obtain a set of parameters to produce the desired results.

One consideration is how to guarantee a differential pair with a differential impedance of 100 Ω over the entire length of the trace. One technique to accomplish this is to change the width of the traces in a differential pair based on how closely one trace is coupled to the other. When the two traces of a differential pair are close and strongly coupled, they should have a width that produces a 100 Ω differential impedance. When the traces split apart to go into a connector, for example, and are no longer so strongly coupled, the width of the traces should be increased to yield a differential impedance of 100 Ω in the new configuration.

TMDS Terminations

The AD8190 provides internal 50 Ω single-ended terminations for all of its high speed inputs and outputs. It is not necessary to include external termination resistors for the TMDS differential pairs on the PCB.

The output termination resistors of the AD8190 back-terminate the output TMDS transmission lines. These back-terminations act to absorb reflections from impedance discontinuities on the output traces, improving the signal integrity of the output traces and adding flexibility to how the output traces can be routed. For example, interlayer vias can be used to route the AD8190 TMDS outputs on multiple layers of the PCB without severely degrading the quality of the output signal.

Auxiliary Control Signals

There are four single-ended control signals associated with each source or sink in an HDMI/DVI application. These are hot plug detect (HPD), consumer electronics control (CEC), and two display data channel (DDC) lines. The two signals on the DDC bus are SDA and SCL (serial data and serial clock, respectively). These four signals can be switched through the auxiliary bus of the AD8190 and do not need to be routed with the same strict considerations as the high speed TMDS signals.

In general, it is sufficient to route each auxiliary signal as a single-ended trace. These signals are not sensitive to impedance discontinuities, do not require a reference plane, and can be routed on multiple layers of the PCB. However, it is best to follow strict layout practices whenever possible to prevent the PCB design from affecting the overall application. The specific routing of the HPD, CEC, and DDC lines depends upon the application in which the AD8190 is being used.

For example, the maximum speed of signals present on the auxiliary lines are 100 kHz I²C data on the DDC lines, therefore, any layout that enables 100 kHz I²C to be passed over the DDC bus should suffice. The HDMI 1.2a specification, however, places a strict 50 pF limit on the amount of capacitance that can be measured on either SDA or SCL at the HDMI input connector.

This 50 pF limit includes the HDMI connector, the PCB, and whatever capacitance is seen at the input of the AD8190, or an equivalent receiver. There is a similar limit of 100 pF of input capacitance for the CEC line.

The parasitic capacitance of traces on a PCB increases with trace length. To help ensure that a design satisfies the HDMI specification, the length of the CEC and DDC lines on the PCB should be made as short as possible. Additionally, if there is a reference plane in the layer adjacent to the auxiliary traces in the PCB stackup, relieving or clearing out this reference plane immediately under the auxiliary traces significantly decreases the amount of parasitic trace capacitance. An example of the board stackup is shown in Figure 33.

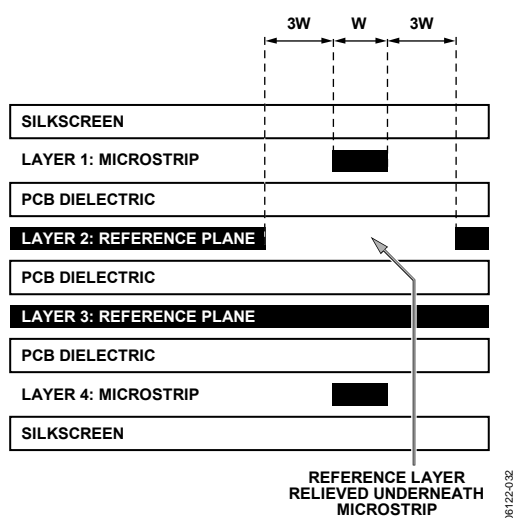

Figure 33. Example Board Stackup

HPD is a dc signal presented by a sink to a source to indicate that the source EDID is available for reading. The placement of this signal is not critical, but it should be routed as directly as possible.

When the AD8190 is powered up, one set of the auxiliary inputs is passively routed to the outputs. In this state, the AD8190 looks like a 100 Ω resistor between the selected auxiliary inputs and the corresponding outputs as illustrated in Figure 27. The AD8190 does not buffer the auxiliary signals, therefore, the input traces, output traces, and the connection through the AD8190 all must be considered when designing a PCB to meet HDMI/DVI specifications. The unselected auxiliary inputs of the AD8190 are placed into a high impedance mode when the device is powered up. To ensure that all of the auxiliary inputs of the AD8190 are in a high impedance mode when the device is powered off, it is necessary to power the AMUXVCC supply as illustrated in Figure 28.

In contrast to the auxiliary signals, the AD8190 buffers the TMDS signals, allowing a PCB designer to layout the TMDS inputs independently of the outputs.

Power Supplies

The AD8190 has five separate power supplies referenced to two separate grounds. The supply/ground pairs are: AVCC/AVEE, VTTI/AVEE, VTTO/AVEE, DVCC/DVEE, and AMUXVCC/DVEE.

The AVCC/AVEE (3.3 V) and DVCC/DVEE (3.3 V) supplies power the core of the AD8190. The VTTI/AVEE supply (3.3 V) powers the input termination (see Figure 25). Similarly, the VTTO/AVEE supply (3.3 V) powers the output termination (see Figure 26). The AMUXVCC/DVEE supply (3.3 V to 5 V) powers the auxiliary multiplexer core and determines the maximum allowed voltage on the auxiliary lines. For example, if the DDC bus is using 5 V I²C, then AMUXVCC should be connected to +5 V relative to DVEE.

In a typical application, all pins labeled AVEE or DVEE should be connected directly to ground. All pins labeled AVCC, DVCC, VTTI, or VTTO should be connected to 3.3 V, and Pin AMUXVCC tied to 5 V. The supplies can also be powered individually, but care must be taken to ensure that each stage of the AD8190 is powered correctly.

Power Supply Bypassing

The AD8190 requires minimal supply bypassing. When powering the supplies individually, place a 0.01 μF capacitor between each 3.3 V supply pin (AVCC, DVCC, VTTI, and VTTO) and ground to filter out supply noise. Generally, bypass capacitors should be placed near the power pins and should connect directly to the relevant supplies (without long intervening traces). For example, to improve the parasitic inductance of the power supply decoupling capacitors, minimize the trace length between capacitor landing pads and the vias as shown in Figure 34.

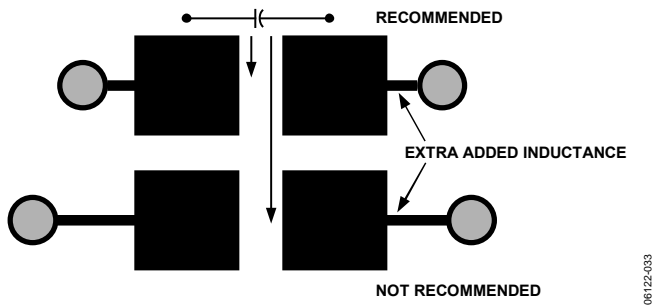

Figure 34. Recommended Pad Outline for Bypass Capacitors

In applications where the AD8190 is powered by a single 3.3 V supply, it is recommended to use two reference supply planes and bypass the 3.3 V reference plane to the ground reference plane with one 220 pF, one 1000 pF, two 0.01 μF , and one 4.7 μF capacitors. The capacitors should via down directly to the

supply planes and be placed within a few centimeters of the AD8190. The AMUXVCC supply does not require additional bypassing. This scheme is illustrated in Figure 35.

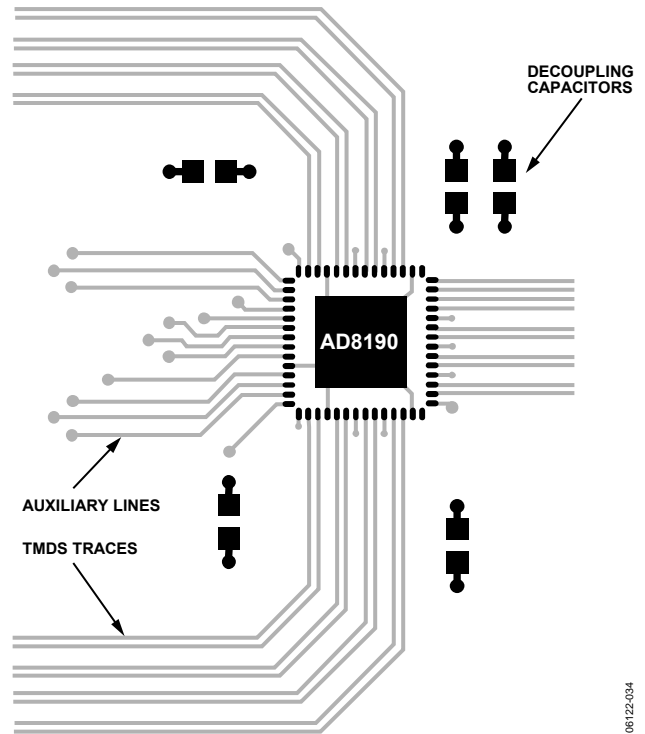
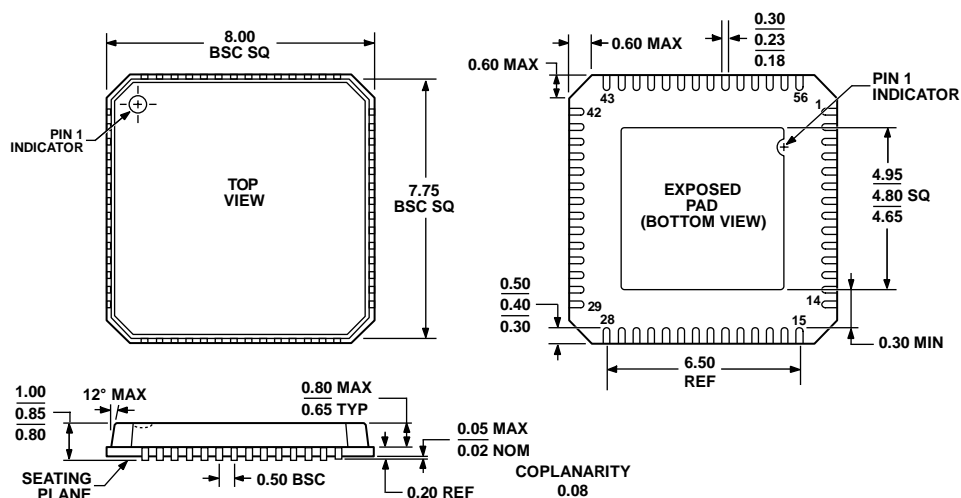

Figure 35. Example Placement of Power Supply Decoupling Capacitors Around the AD8190

OUTLINE DIMENSIONS



COMPLIANT TO JEDEC STANDARDS MO-220-VLLD-2

NOTE:
 THE AD8190 HAS A CONDUCTIVE HEAT SLUG TO HELP DISSIPATE HEAT AND ENSURE RELIABLE OPERATION OF THE DEVICE OVER THE FULL DVI/HDMI TEMPERATURE RANGE. THE SLUG IS EXPOSED ON THE BOTTOM OF THE PACKAGE AND ELECTRICALLY CONNECTED TO AVEE. IT IS RECOMMENDED THAT NO PCB SIGNAL TRACES OR VIAS BE LOCATED UNDER THE PACKAGE THAT COULD COME IN CONTACT WITH THE CONDUCTIVE SLUG. ATTACHING THE SLUG TO A AVEE PLANE WILL REDUCE THE JUNCTION TEMPERATURE OF THE DEVICE WHICH MAY BE BENEFICIAL IN HIGH TEMPERATURE ENVIRONMENTS.

053106-A

Figure 36. 56-Lead Lead Frame Chip Scale Package [LFCSP_VQ]
 8 mm × 8 mm Body, Very Thin Quad
 (CP-56-3)
 Dimensions shown in millimeters

ORDERING GUIDE

| Model | Temperature Range | Package Description | Package Option | Ordering Quantity |
|----------------------------|-------------------|--|----------------|-------------------|
| AD8190ACPZ ¹ | -40°C to +85°C | 56-Lead Lead Frame Chip Scale Package [LFCSP_VQ] | CP-56-3 | 750 |
| AD8190ACPZ-R7 ¹ | -40°C to +85°C | 56-Lead Lead Frame Chip Scale Package [LFCSP_VQ], Reel | CP-56-3 | |
| AD8190-EVAL | | Evaluation Kit | | |

¹ Z = Pb-free part.

AD8190

NOTES

Purchase of licensed I²C components of Analog Devices or one of its sublicensed Associated Companies conveys a license for the purchaser under the Philips I²C Patent Rights to use these components in an I²C system, provided that the system conforms to the I²C Standard Specification as defined by Philips.